

Article number: 201240156

Description: E+G Retaining magnets with smooth stud GN 52.4-ND-25-M6-E  
Neodymium, iron, boron - 80° C, 190N

## Measures

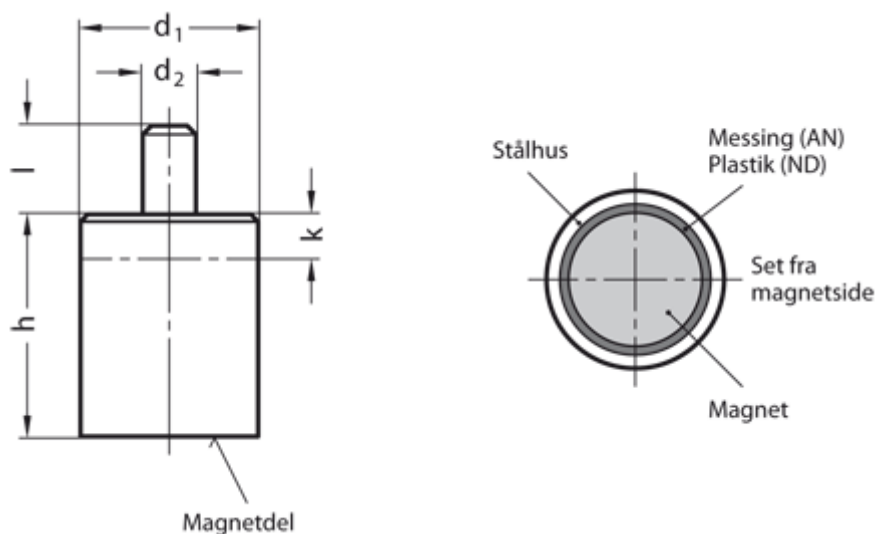

d1 = 25

d2 = 8

h = 35 ±0,2

Holding force N = 190.0

k = 13 mm - Max. dimension the magnet can be shortened

l = 10

Material = ND Neodym, iron, boron, 80°C